





Manufacturers part numbers are quoted for reference only

| Type | Baumuster |
|---|---|
| Euro I 12/84 → | 357.400 357.401 |
|  | 357.402 357.404 |
|  | 357.406 357.410 |
| Stadtomnibus | 357.415 612.400 612.402 |
| WB 5875 | 612.401 612.402 |
|  OM 447 H 12,0 ltr. 6 cyl. 150 KW/204 HP 157 KW/213 HP 177 KW/240 HP | 612.403 612.410 612.411 612.412 612.413 612.420 |
|  OM 447 HA 12,0 ltr. 6 cyl. 184 KW/250 HP | 612.422 357.420 357.422 357.454 |
|  OM 447 HLA 12,0 ltr. 6 cyl. 157 KW/213 HP 184 KW/250 HP 220 KW/300 HP | 357.455 357.460 357.461 357.464 357.465 357.470 357.474 |

Front pipe

51125
834.100.0254
621.490.0065



52273
357.490.3719
357.490.3919
357.490.3419
Insulated
Excl. BM 357.400-402, 404, 406,
410, 415, 420, 422, 454, 455, 460



52275
357.490.3019
357.490.2819
BM 357.400-402, 404, 406, 410,
415, 420, 422, 454, 455, 460



Silencer

50433
357.490.1501
357.490.1102
357.490.0701

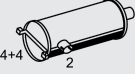

Tail pipe

52758
357.490.2621
Ceramic insulation



N.A.
357.492.3304

Mounting Parts

1.
50849
621.997.0090



2.
99704
071.555.104.501
940.492.0240



3.
99700
071.555.100.501
940.492.0340



4.
50809
381.492.0082
301.492.0382
0201.175.00



Horizontal
LHD
Standard