





Manufacturers part numbers are quoted for reference only

Type	Baumuster
Euro II	356.225
09/91 → 10/99	356.235
	356.255
	356.303
	356.313
	356.323
WB 5245, 6250	356.333
	356.343
 OM 442 LA	356.353
14,7 ltr.	356.363
8 cyl.	356.373
213 KW/290 HP	356.403
 OM 402 LA	356.405
12,8 ltr.	356.406
8 cyl.	356.413
280 KW/381 HP	356.415
	356.425
	356.435
	356.443
	356.445
	356.455
	356.465
	356.473
	356.475
	356.485
	356.495
	614.313
	614.413
	614.415
	614.435
	614.445
	614.448

Front pipe

51125
834.100.0254
621.490.0065



51126
621.492.0008



52276
618.492.0201
356.492.1501



51125
834.100.0254
621.490.0065



51126
621.492.0008



Silencer

50434
356.490.0001

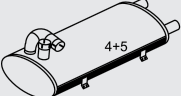

Tail pipe

52761
356.490.0121
613.490.0021
356.490.0221



52761
356.490.0121
613.490.0021
356.490.0221



Mounting Parts

1.
50849
621.997.0090



2.
50916
625.492.0040



3.
99704
071.555.104.501
940.492.0240



4.
50809
381.492.0082
301.492.0382
0201.175.00



5.
50991



Horizontal
LHD
Standard