

Manufacturers part numbers are quoted for reference only

Type

Euro II
10/93 →



A10
A11
A12

D0826
LUH/LUH213
7,0 ltr.
6 cyl.
157 KW/213 HP

D0826
LUH01-06/
08/10/12/13
7,0 ltr.
6 cyl.
162 KW/220 HP
169 KW/230 HP
191 KW/260 HP
198 KW/270 HP

DAB S15
Mark II

Front pipe

49274
81.15204.0411
81.15204.5552



49141
81.15204.5617

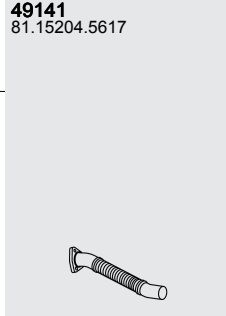

Silencer

49337
81.15101.0238
81.15101.0250

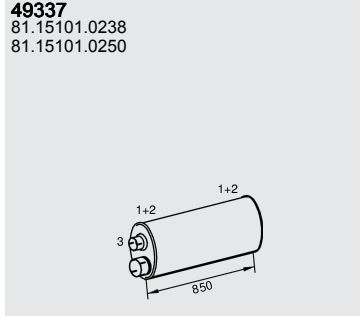

Tail pipe

49694
88.15204.5525
81.15204.5525

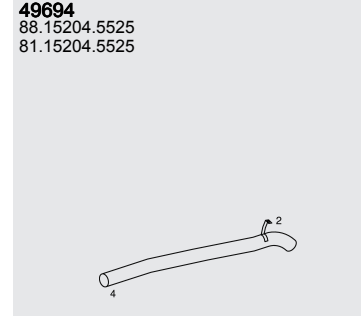

Mounting Parts

1.
49841
81.15502.5079
81.15501.6023
81.15502.5120

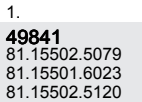

2.
49907
81.96210.0052



3.
99785
06.67041.0121
81.97420.0023
06.67041.0133

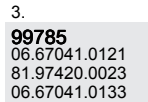

4.
99794
81.97420.0140
06.67041.0125
85.15640.0001

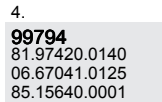

Horizontal
LHD
Standard