

Manufacturers part numbers are quoted for reference only

Type

Euro III
34/03 →



A39
(ND313)

D2866 LUH23/
24/25/27-30,
34-37,50-52
12,0 ltr.
6 cyl.
191 KW/260 HP
228 KW/310 HP
265 KW/360 HP
301 KW/410 HP

Front pipe

48130
81.15205.5129



Silencer

47324
81.15103.6003

DPF
Complete unit
Replaced to parts:6,7,8,9,10,11

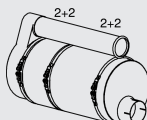

Tail pipe

47741
81.15205.5189

Tail pipe left rear below rear corner



Mounting Parts

1.
70804
06.67410.3115
06.67419.0009



2.
49910
81.96210.0153
81.96210.0127
81.96210.0602



3.
99714
81.97420.0085
88.15640.2203
81.97420.0152



4.
49838
81.96210.0101



5.
49864
81.97488.0534
81.97487.0780



6. Inlet
49950
81.15103.0019



7. CAT
47001
81.15103.0020



8. 81.15230.0024
N.A

9. Outlet
49951
81.15103.0021



10. Gasket for Pos.
6+7, 7+8, 8+9
49940
81.15103.0022



11. V-clamp for
Pos. 6+7, 7+8, 8+9
78825
81.15103.0004



Horizontal
LHD/RHD
Standard