

Manufacturers part numbers are quoted for reference only

Type

Euro IV
04/2004 →



- ⊗ X e
- ⊗ X e
- ⊗ X e/e
- ⊗ X e/e
- ⊗ X e
- ⊗ X e

DC 16.05/06/08
15,6 ltr.
8 cyl.
368 KW/500 HP
412 KW/560 HP
456 KW/620 HP

R500/R560/R620

Front pipe

Silencer

Tail pipe

68089
1545481

►CHno 2055726SSS
►CHno 3666160SLA
►CHno 5243181SNL
►CHno 9150583SAN



68343
1914724
1944683
1548344
SCR
Complete unit
Replacable parts: 3,4,5,6,7,8

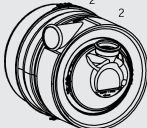

68518
1722410

CR 16



68522
1755642



68741
1727567

L=1064 mm

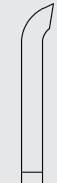

68742
1727568

L=734 mm



68038
1939979

2055727SSS ►CHno
3666162SLA ►CHno
5243182SNL ►CHno
9150584SAN ►CHno



68519
1722411

CR 19



68728
1722409



Mounting Parts

1.
68858
1431579



2.
68876
1774413



3. SCR filter
68020
1928893
1541622



4. Outlet cover
68887
1731524



5. End cover
68885
1930402
1731535



6. V-clamp for Pos.5
68881
1865797
1538692



7. V-clamp for Pos.4
68882
1865796
1538689



8. Sealing ring for Pos.5
68883
1928746
1731285



Vertical
LHD/RHD
Standard