

Manufacturers part numbers are quoted for reference only

Type

Euro IV
04/2004 →



⊗X ⊗
⊗X ⊗
⊗X ⊗/⊗
⊗X ⊗/⊗

DC 16
15,6 ltr.
8 cyl.
368 KW/500 HP
412 KW/560 HP
456 KW/620 HP

R500/R560/R620

Front pipe

Silencer

Tail pipe

68089
1545481

▶CHno 2055726SSS
▶CHno 3661660SLA
▶CHno 5243181SNL
▶CHno 9150583SAN

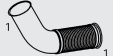

68343
1914724
1944683
1548344
SCR
Complete unit
Replacable parts: 3,4,5,6,7,8

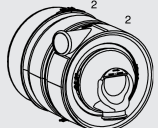

68602
1728241

▶CHno 2017013 SSS
▶CHno 5147120 SNL
▶CHno 9110331 SAN
▶CHno 3587157 SLA

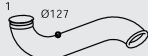

68603
1760833

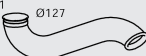

68038
1939979

2055727SSS ▶CHno
3666161SLA ▶CHno
5243182SNL ▶CHno
9150584SAN ▶CHno



68615
1770281

2017014 SSS ▶CHno
5147121 SNL ▶CHno
9110332 SAN ▶CHno
3587158 SLA ▶CHno

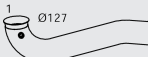

Mounting Parts

1.
68858
1431579



2.
68876
1774413



3. SCR filter
68020
1928893
1541622



4. Outlet cover
68887
1731524



5. End cover
68885
1930402
1731535



6. V-clamp for
Pos. 5
68881
1865797
1538692



7. V-clamp for
Pos. 4
68882
1865796
1538689



8. Sealing ring
for Pos. 5
68883
1928746
1731285



Horizontal
LHD/RHD
Standard