

82.1

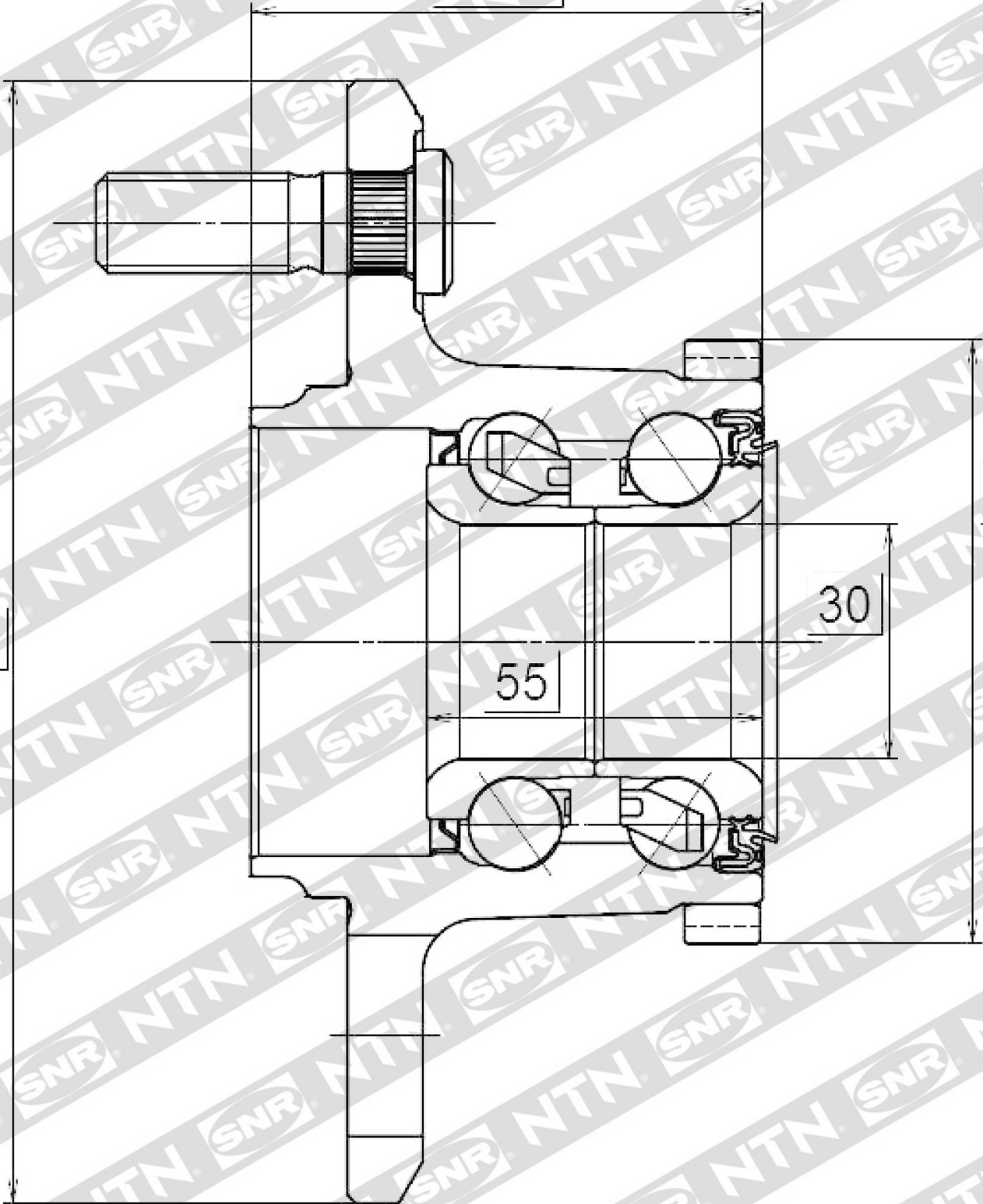

142

55

30

77

R19004