

62

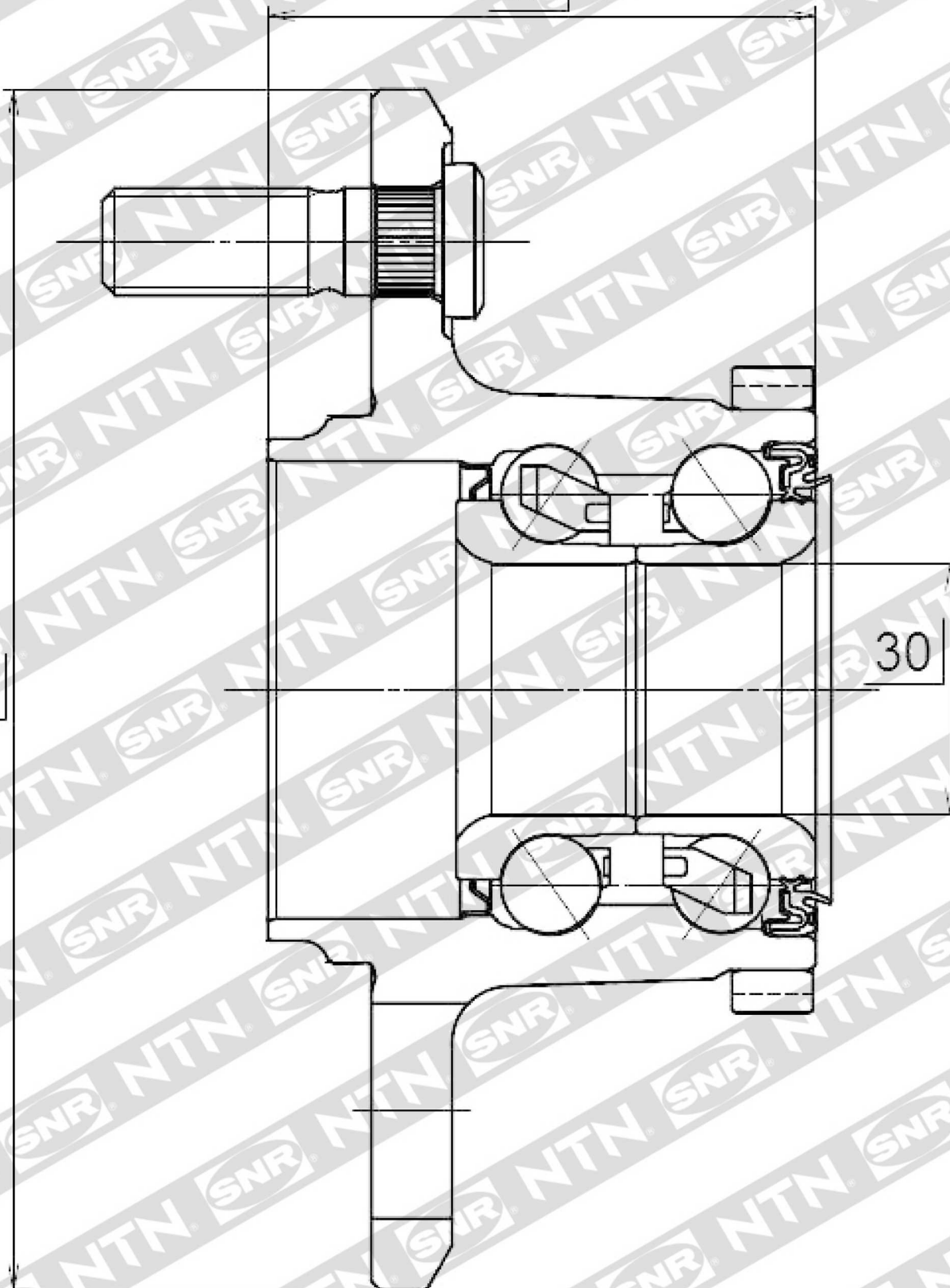

136

30

R19002