

60.5

134

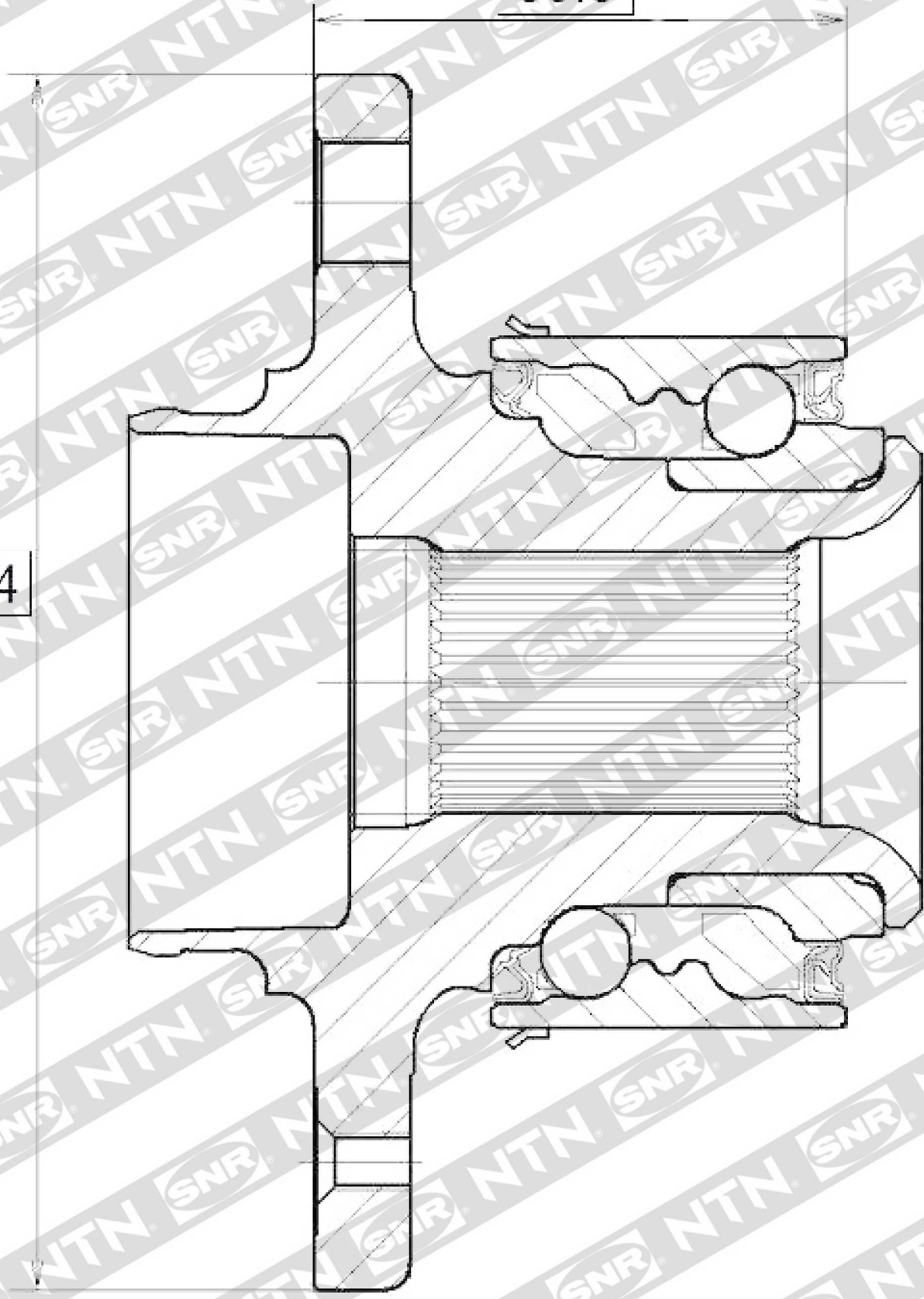

R18703