

46

134

28

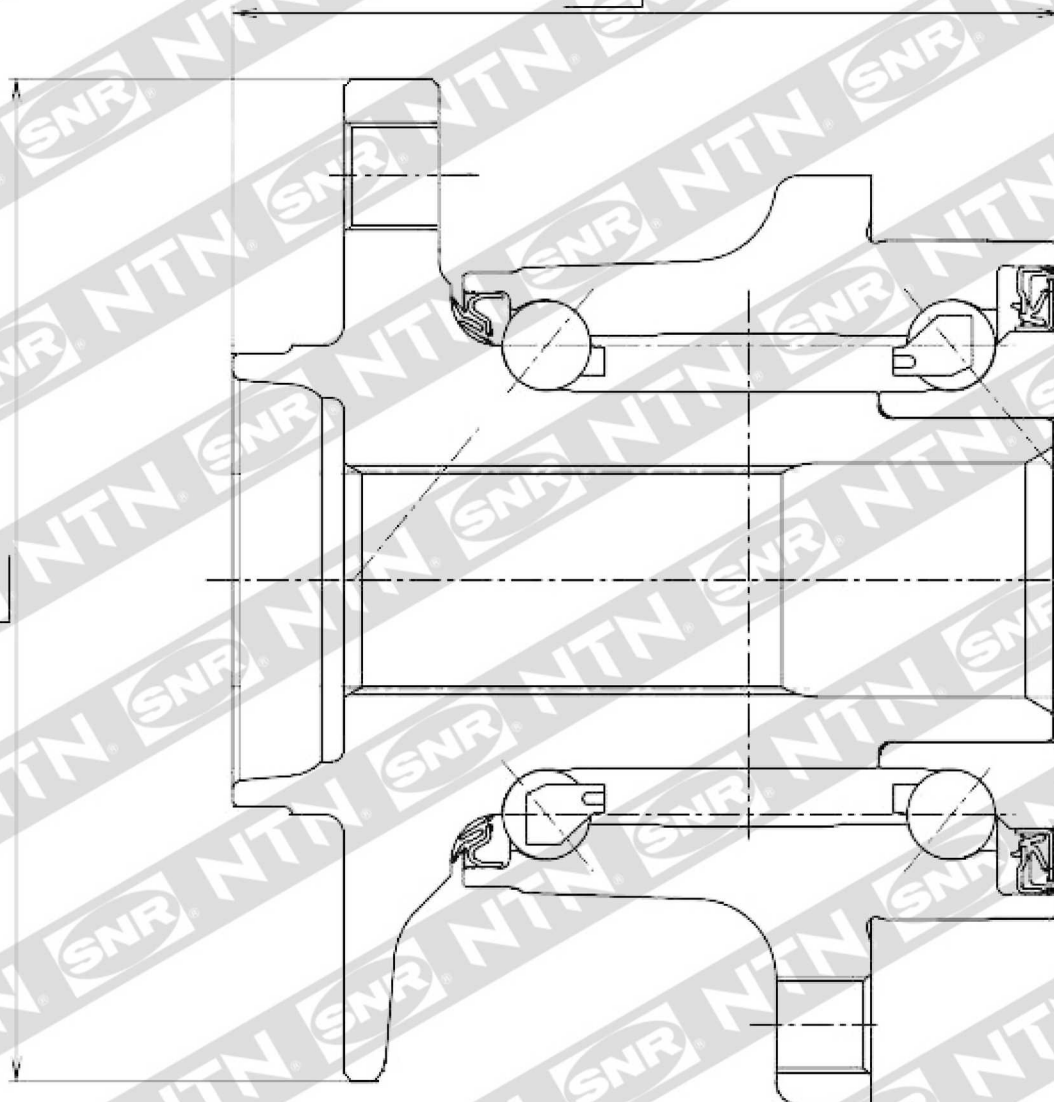

R18701