

71.2

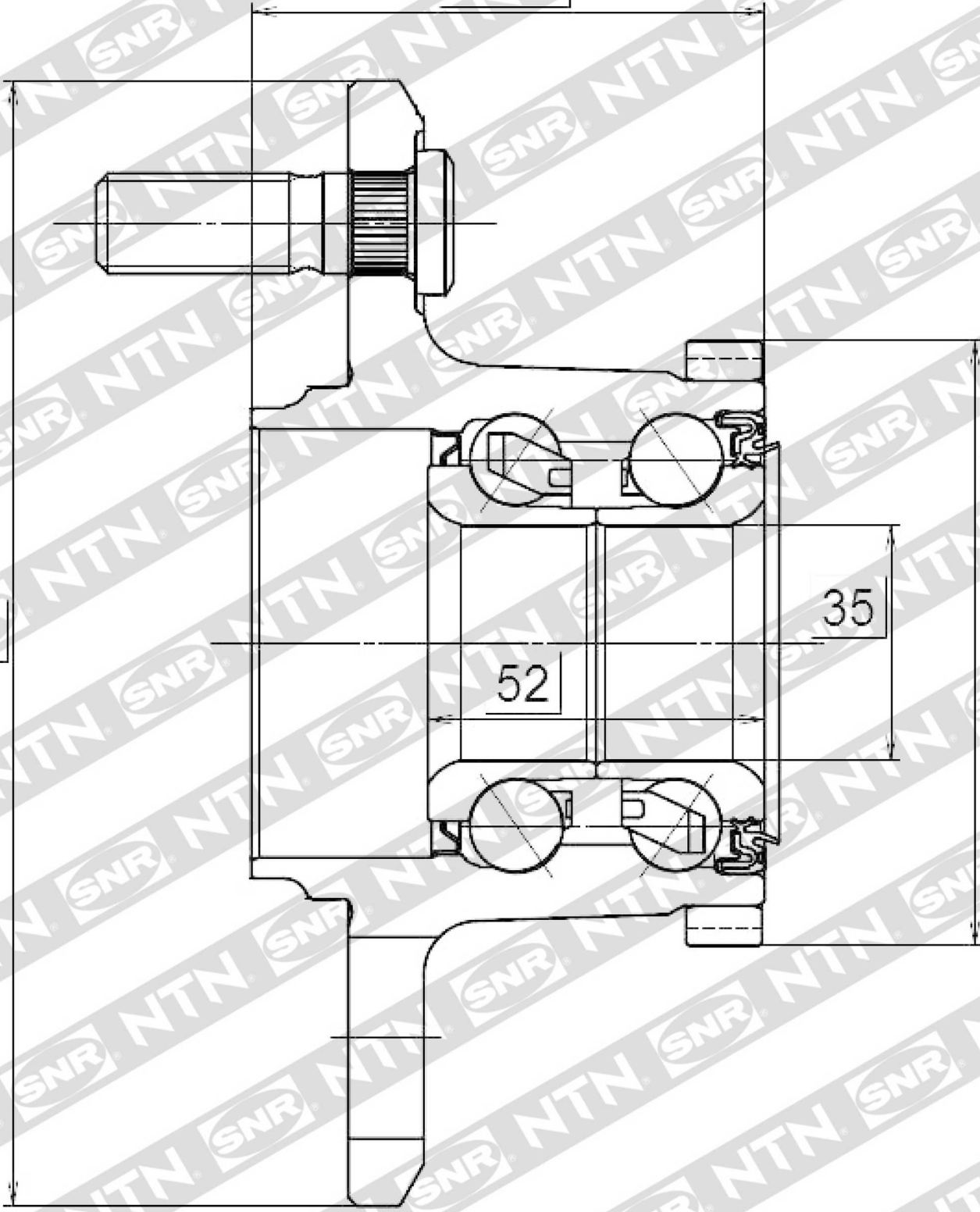

148

52

35

90

R18429