

62

120

30

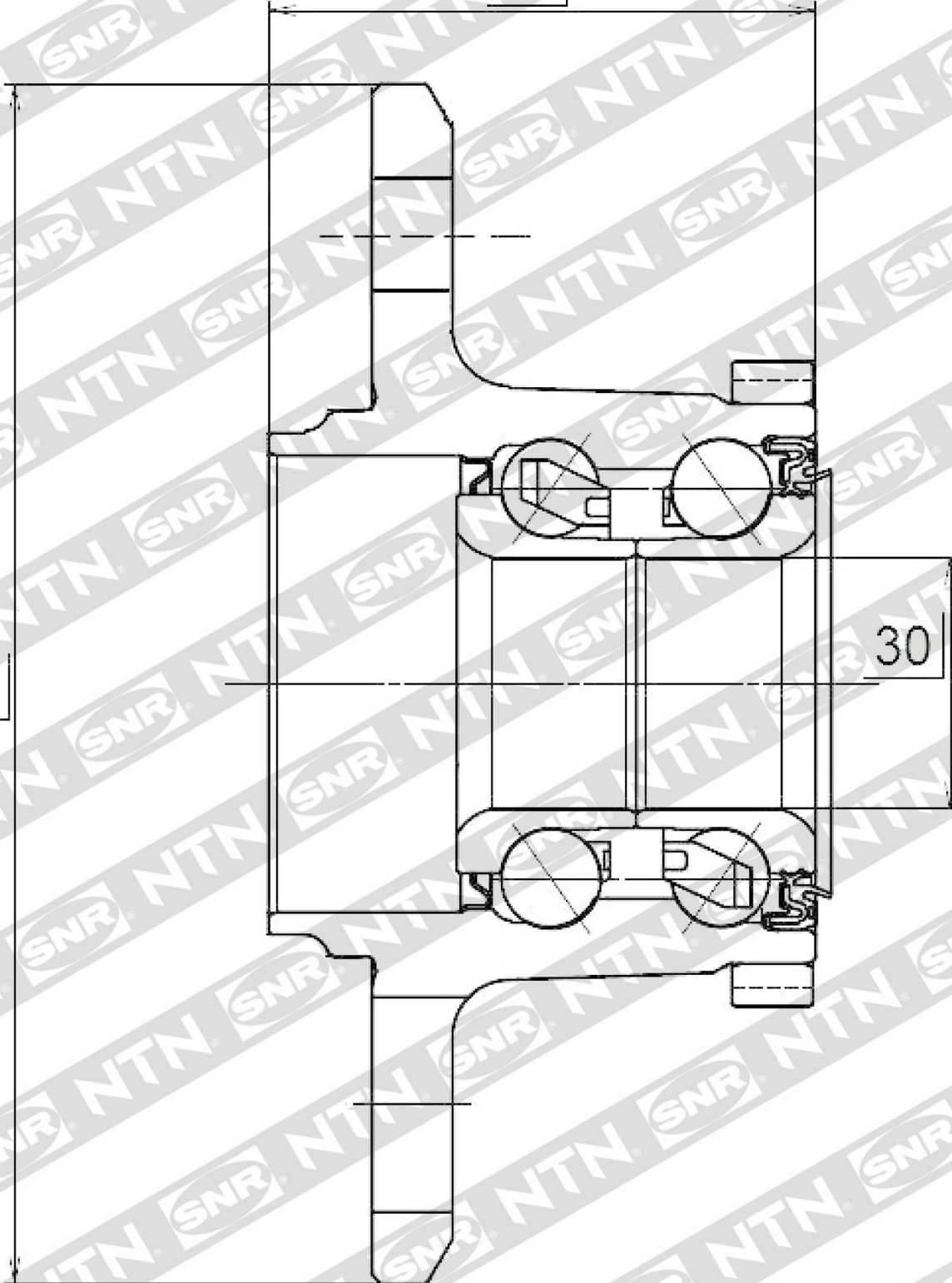

R18261