

83.5

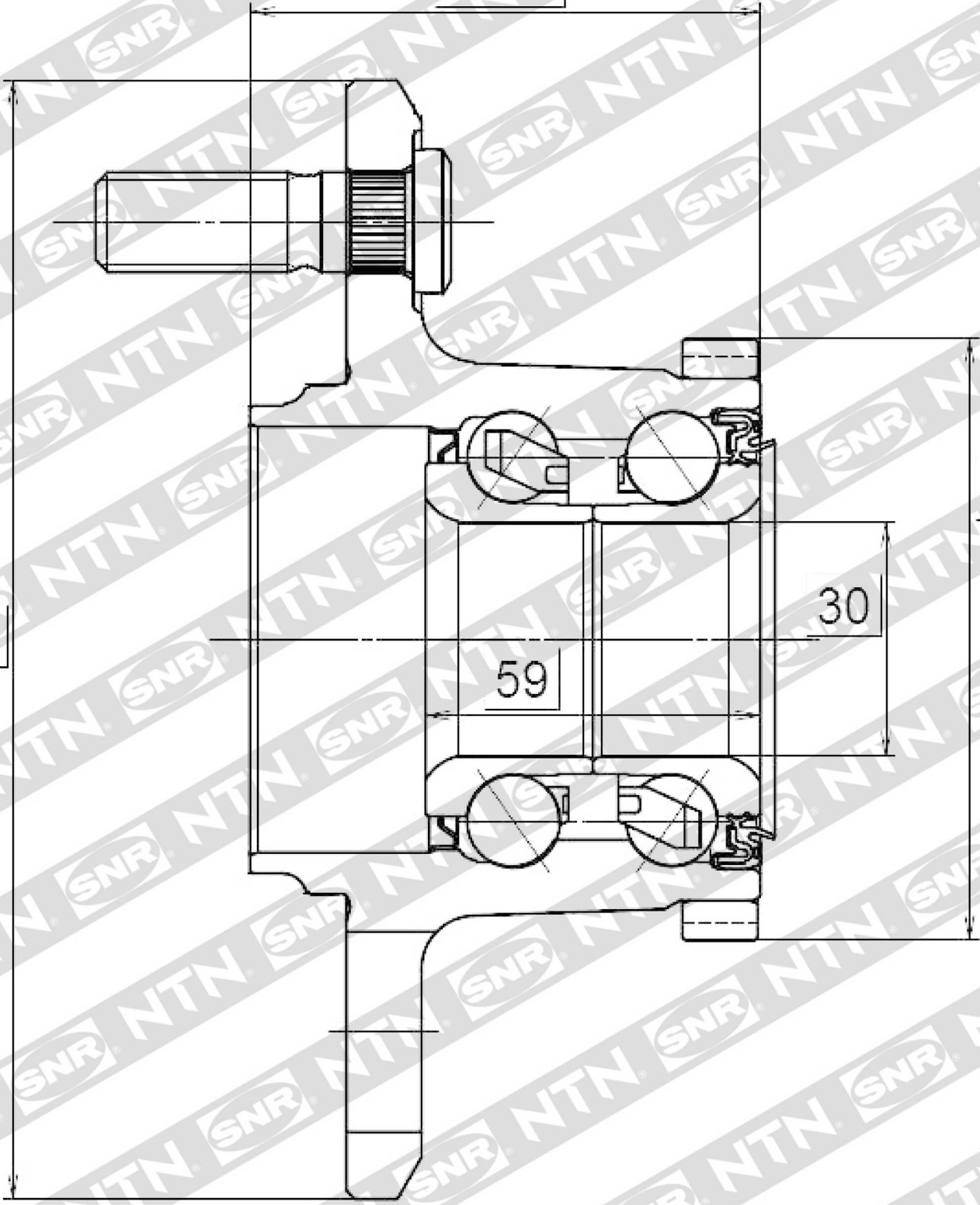

152

79

30

59

R17457