

74

152

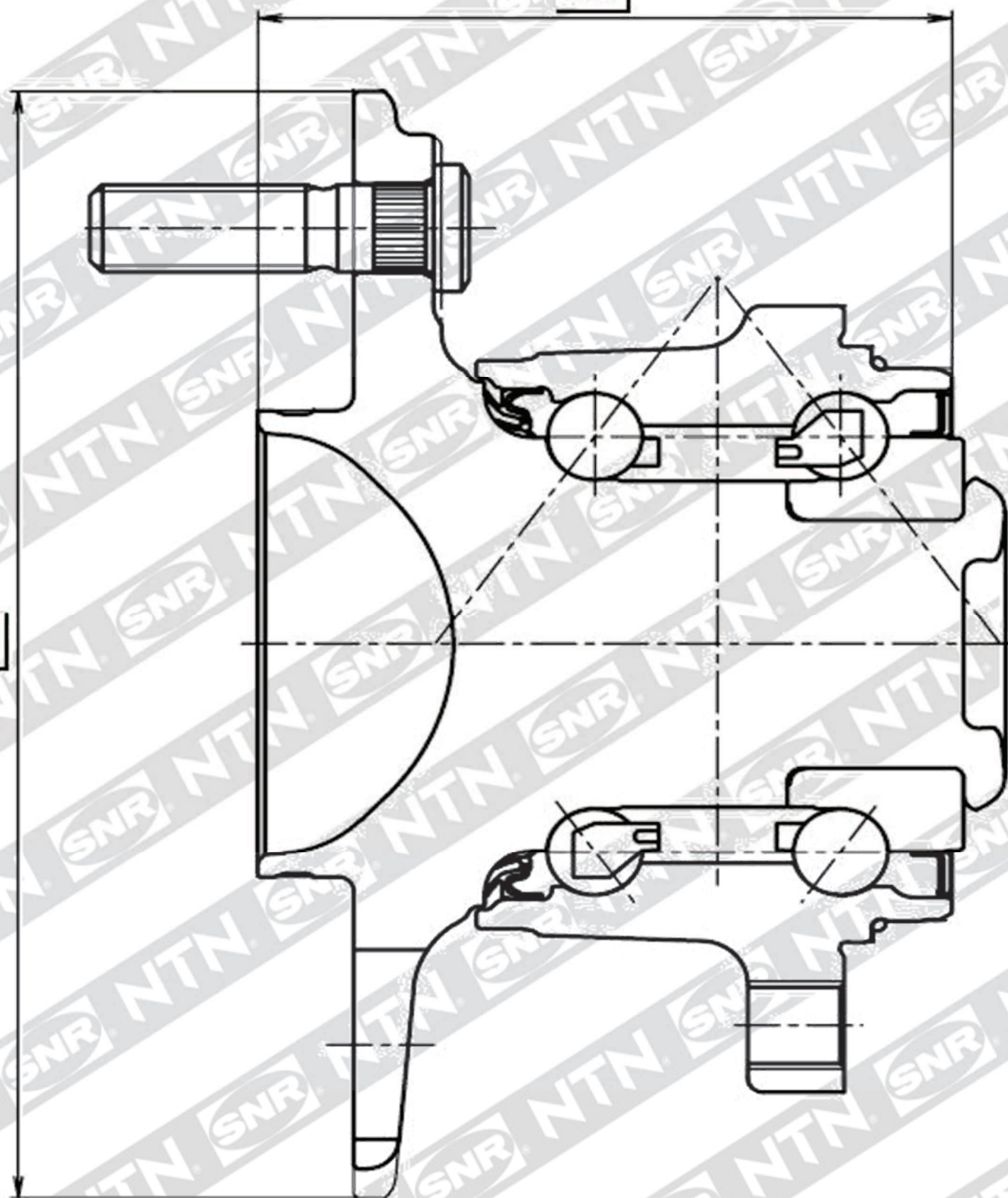

R16999