

76.4

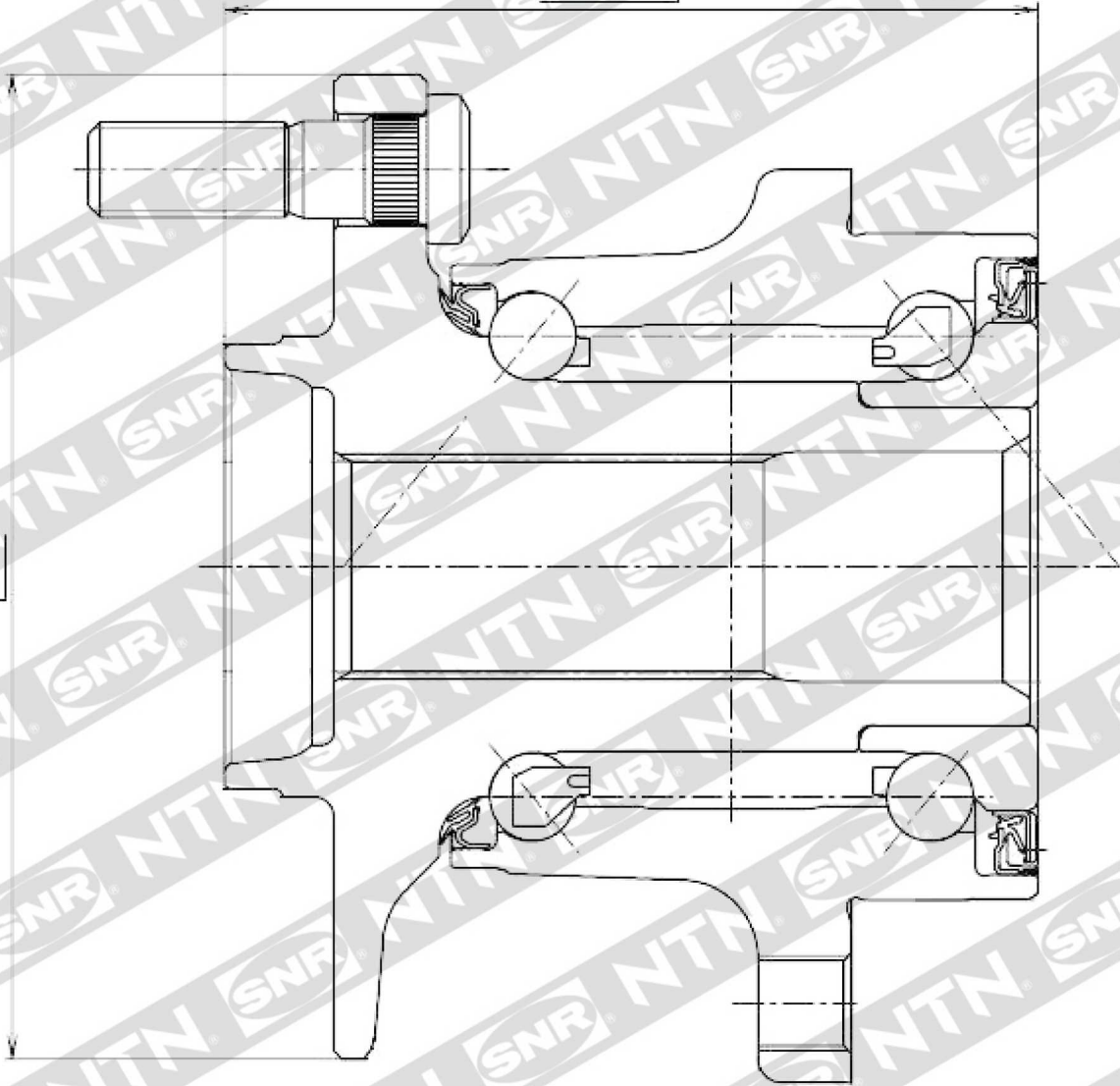

139

R16971