

64.5

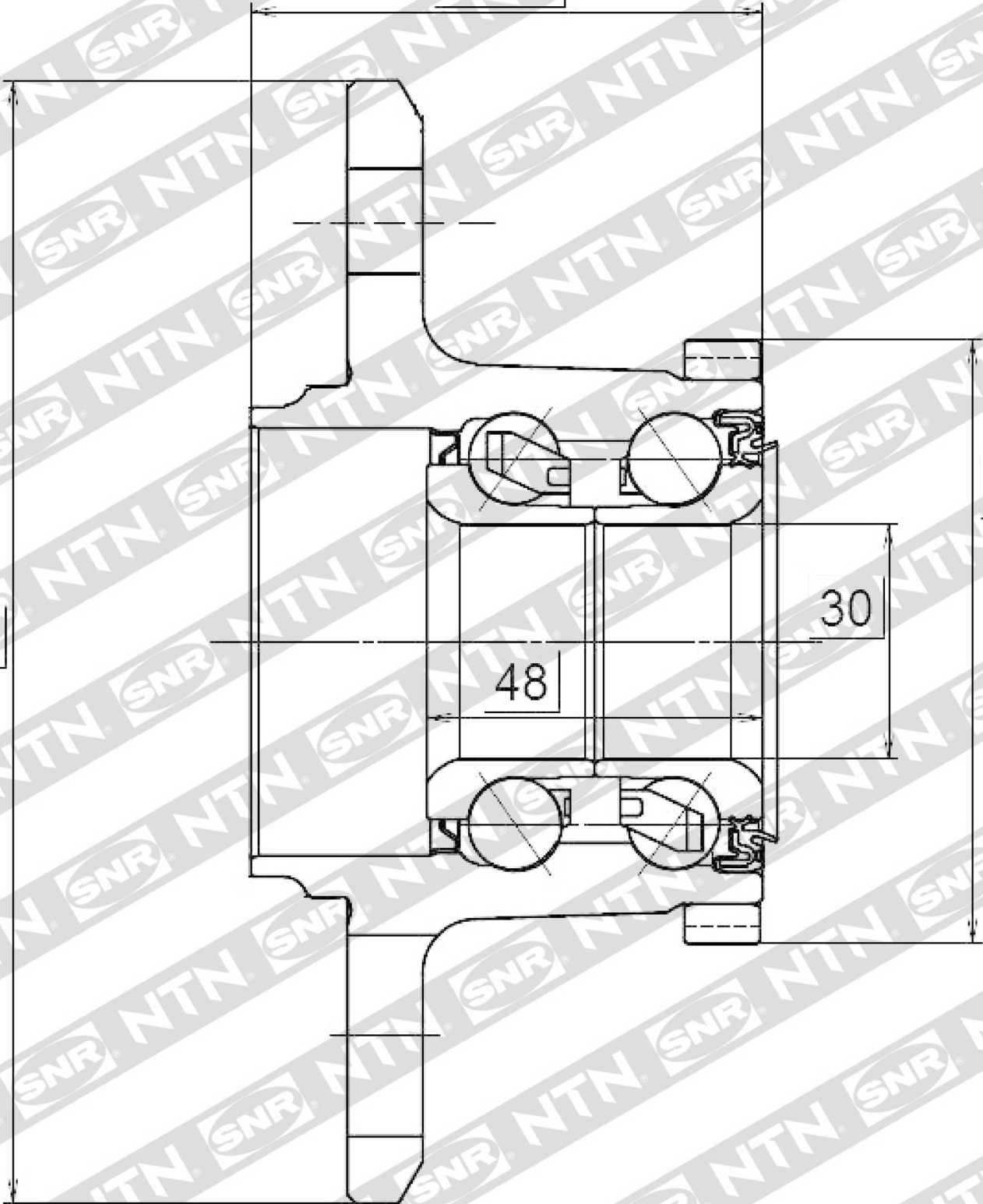

148

72

30

48

R16884