

136

99.5

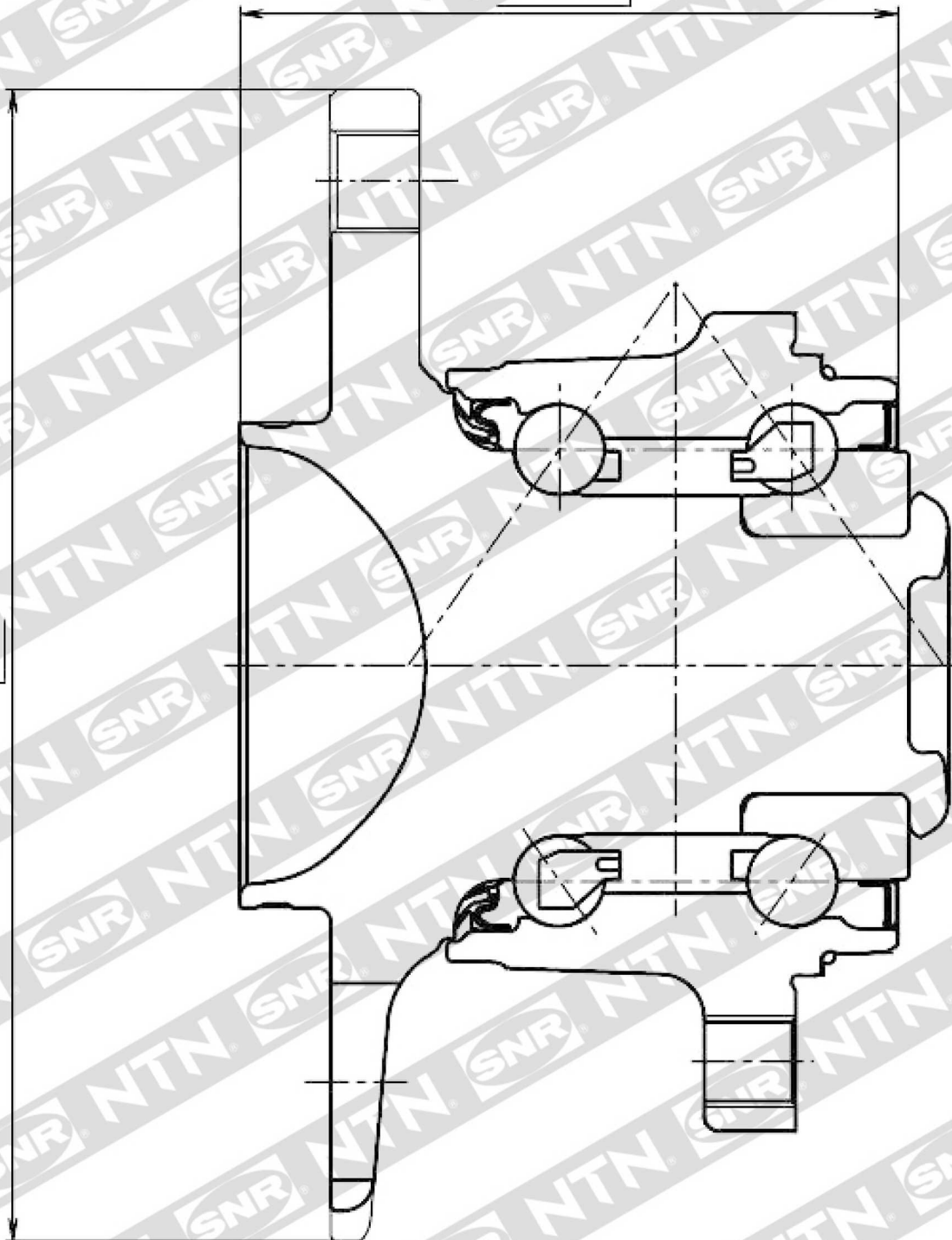

R16534