

70

137

43

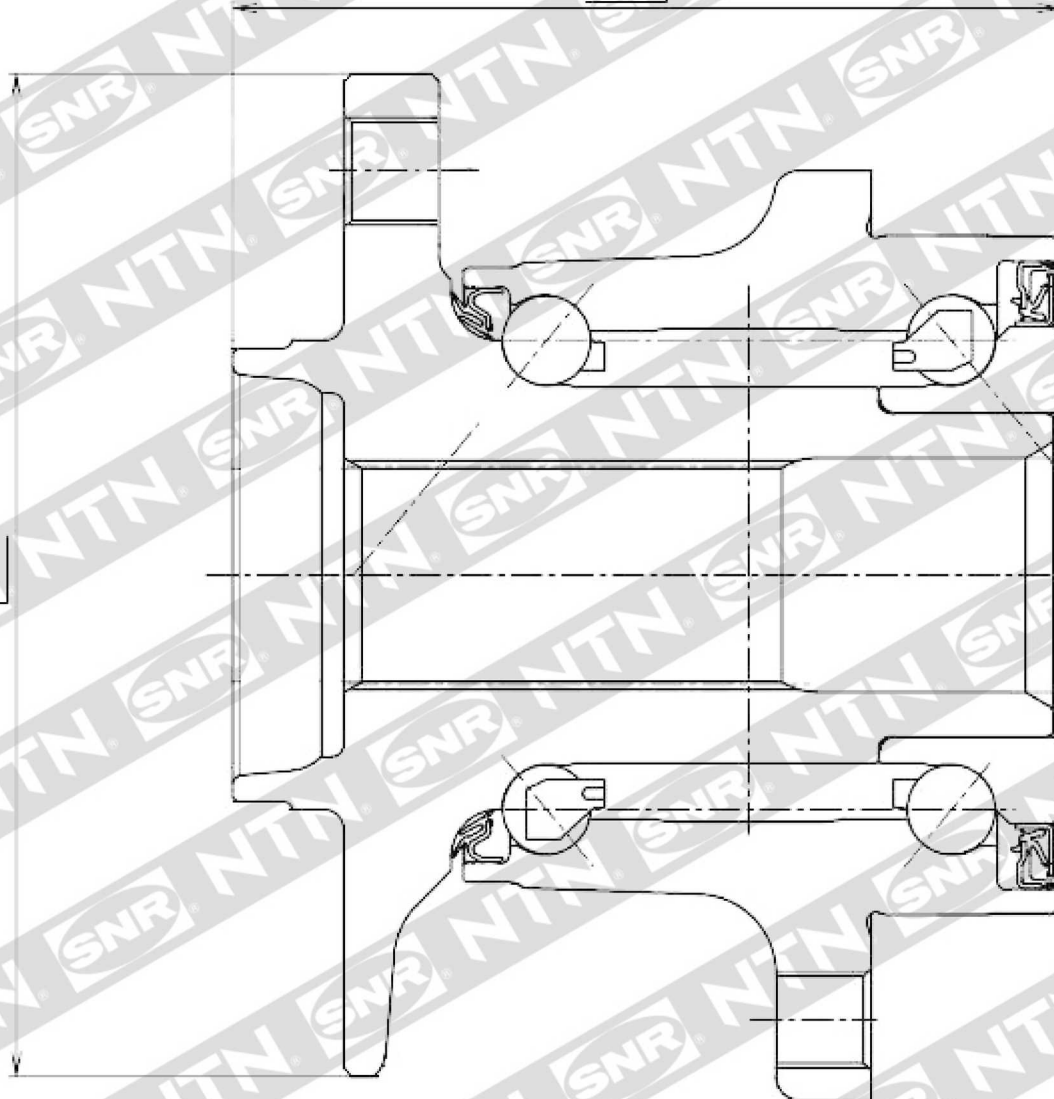

R16252