

137

87.5

43

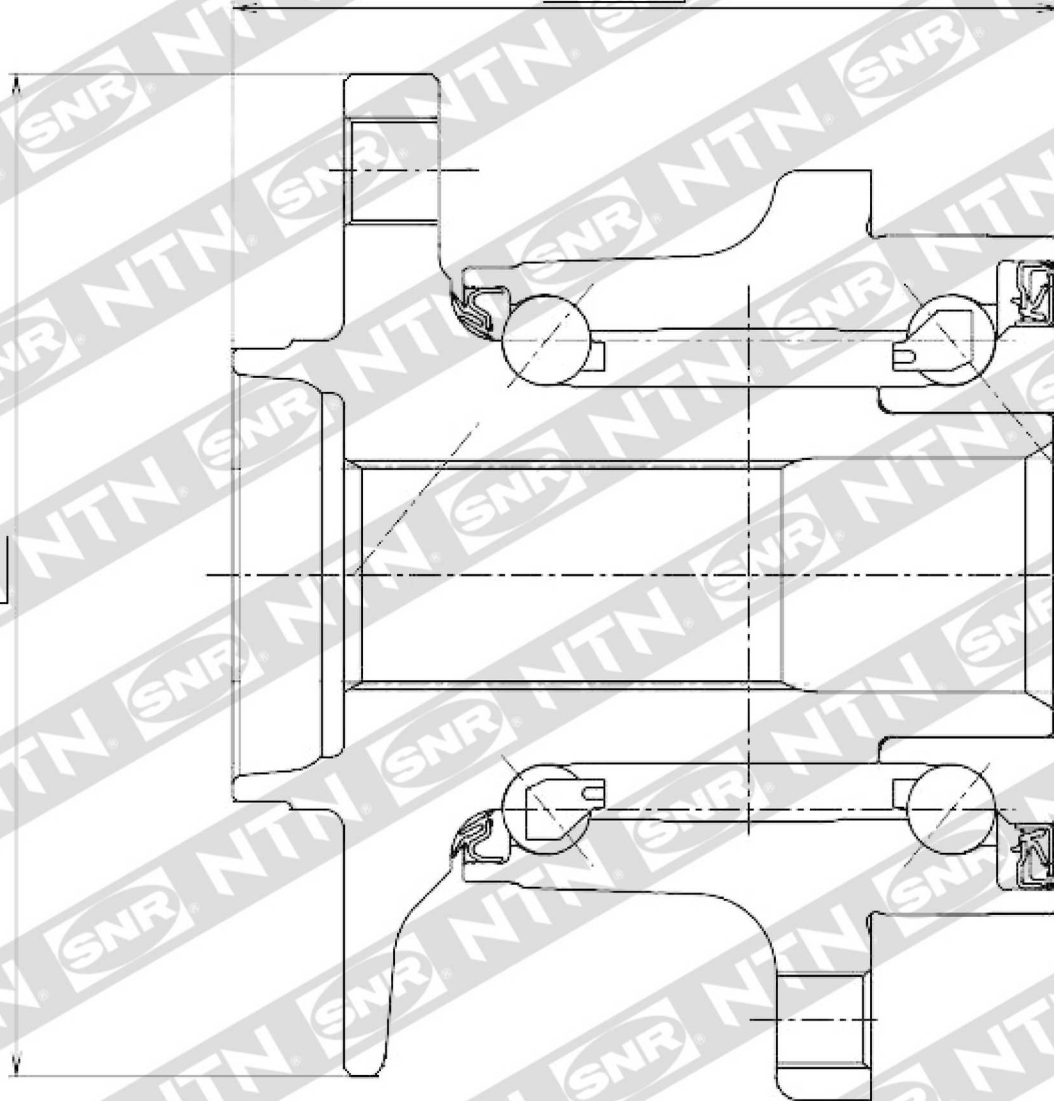

R16251