

66

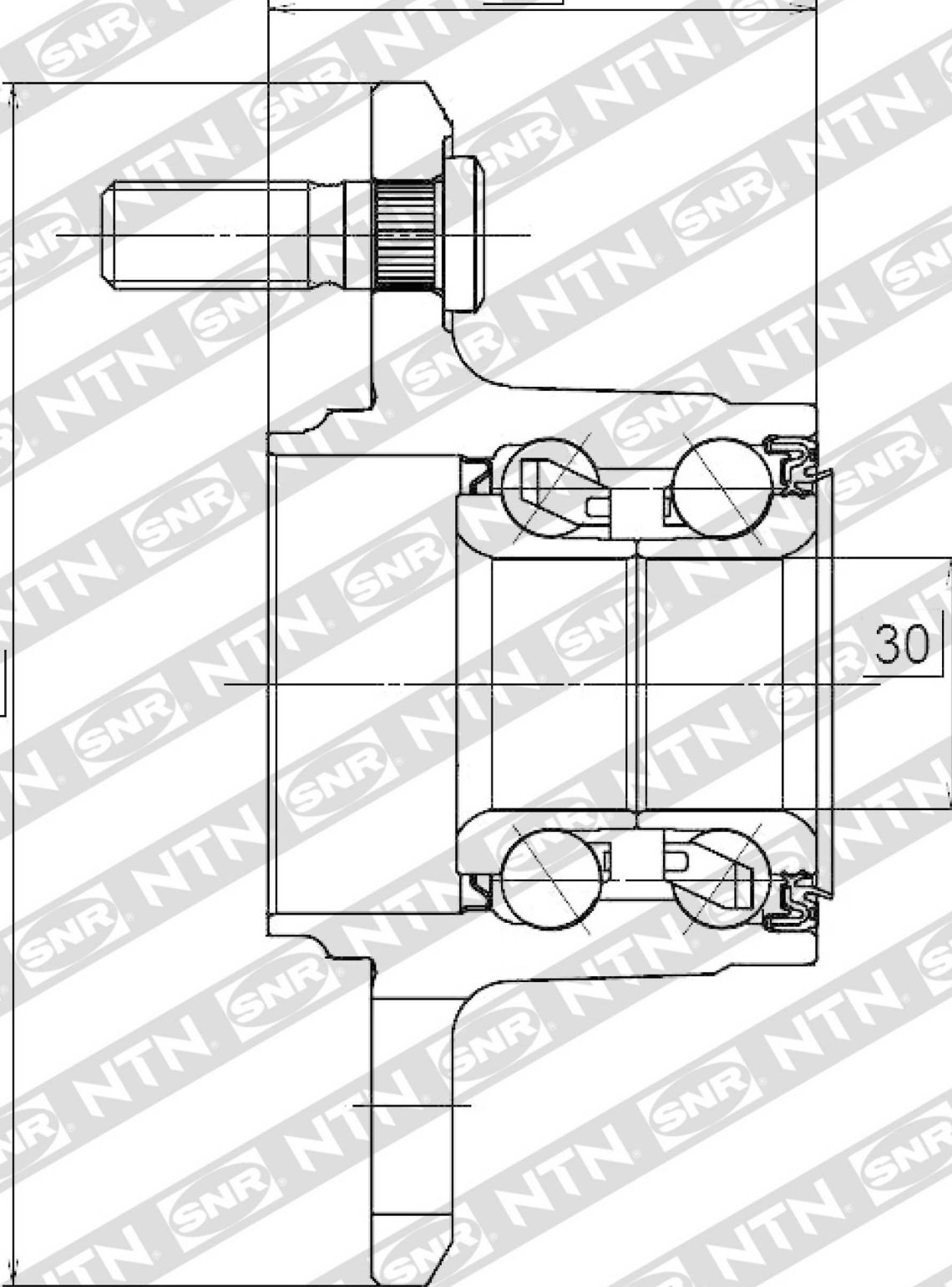

136

30

R16122