

73.4

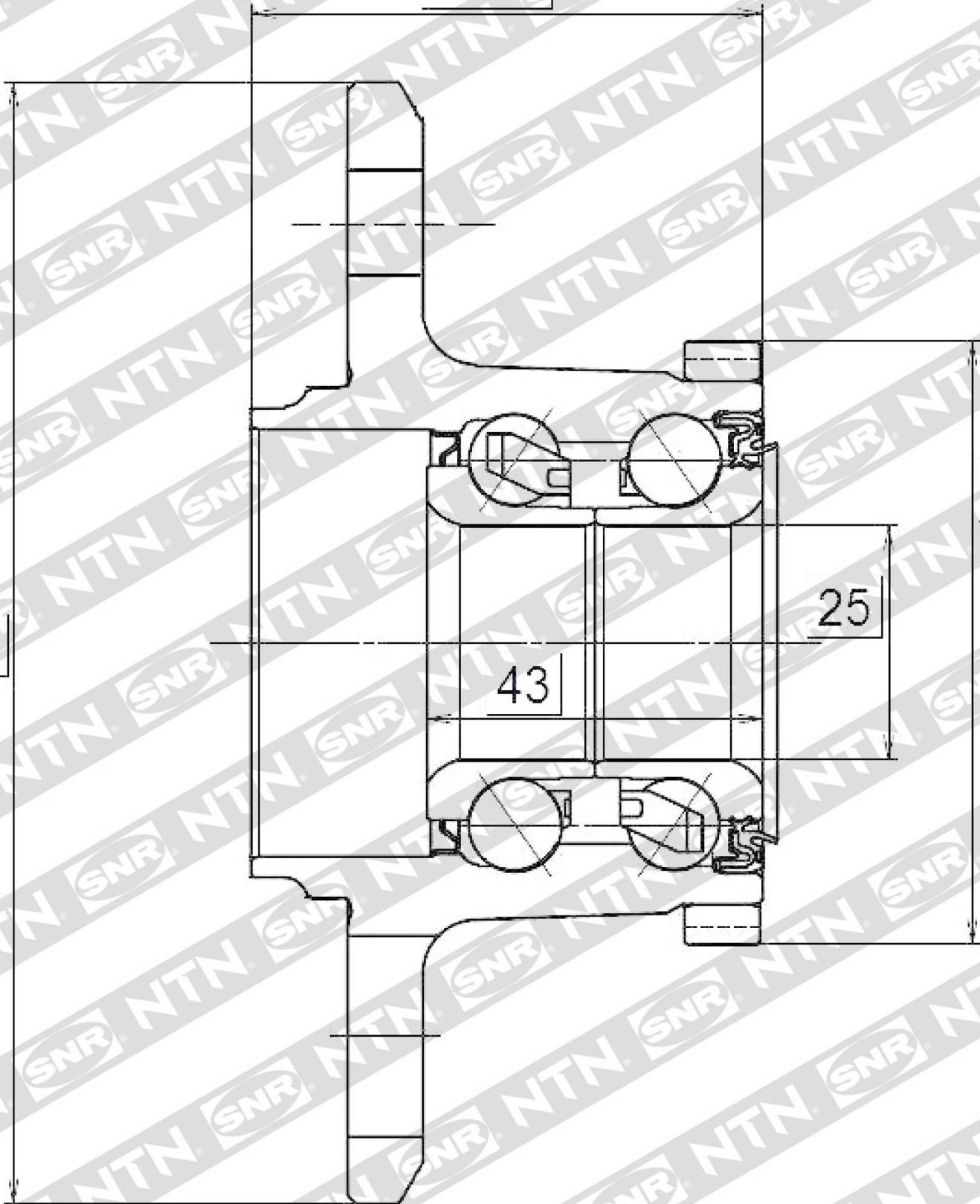

79

133

25

43

R15582