

78.26

146

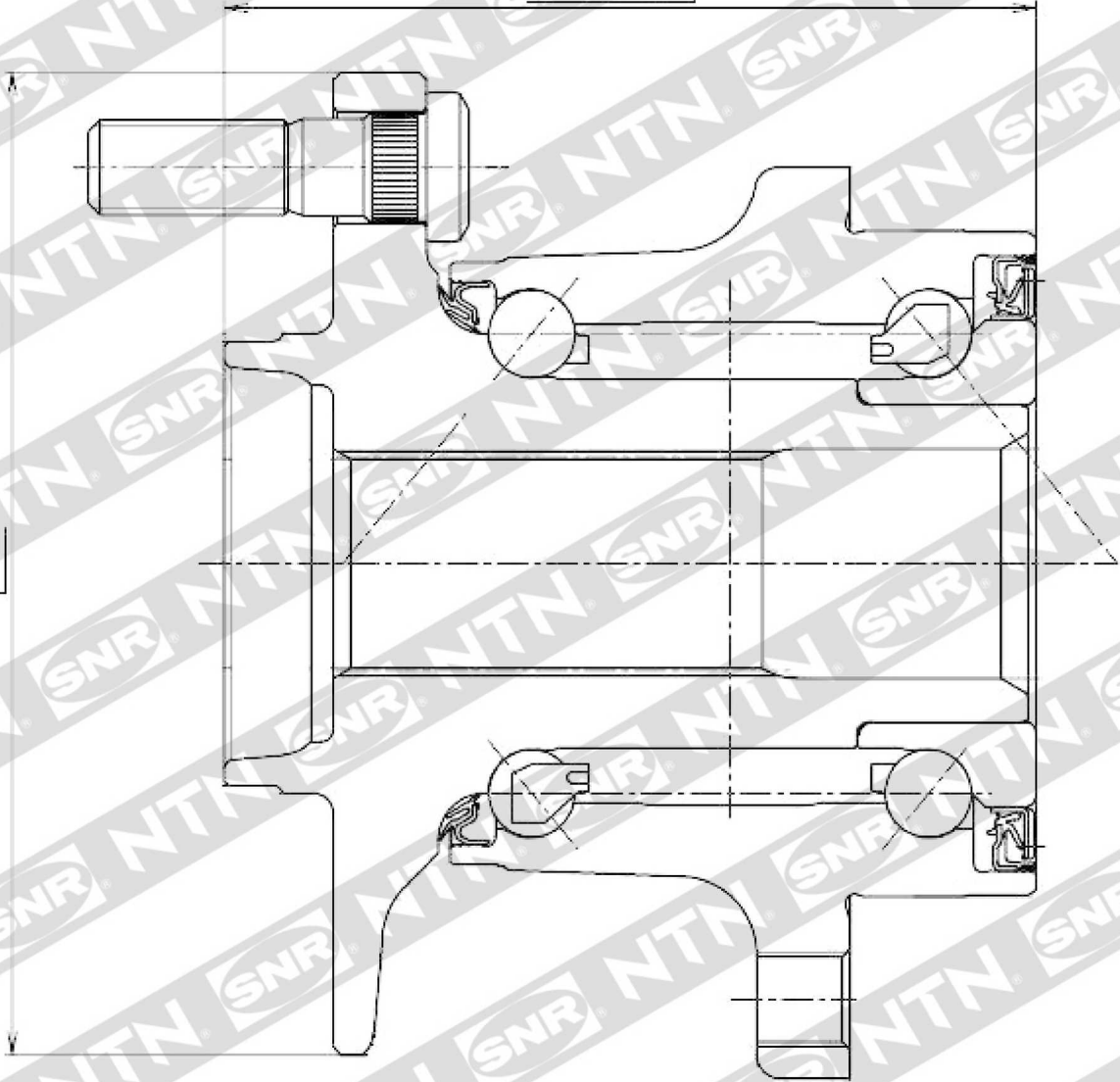

R15369