

87.45

157

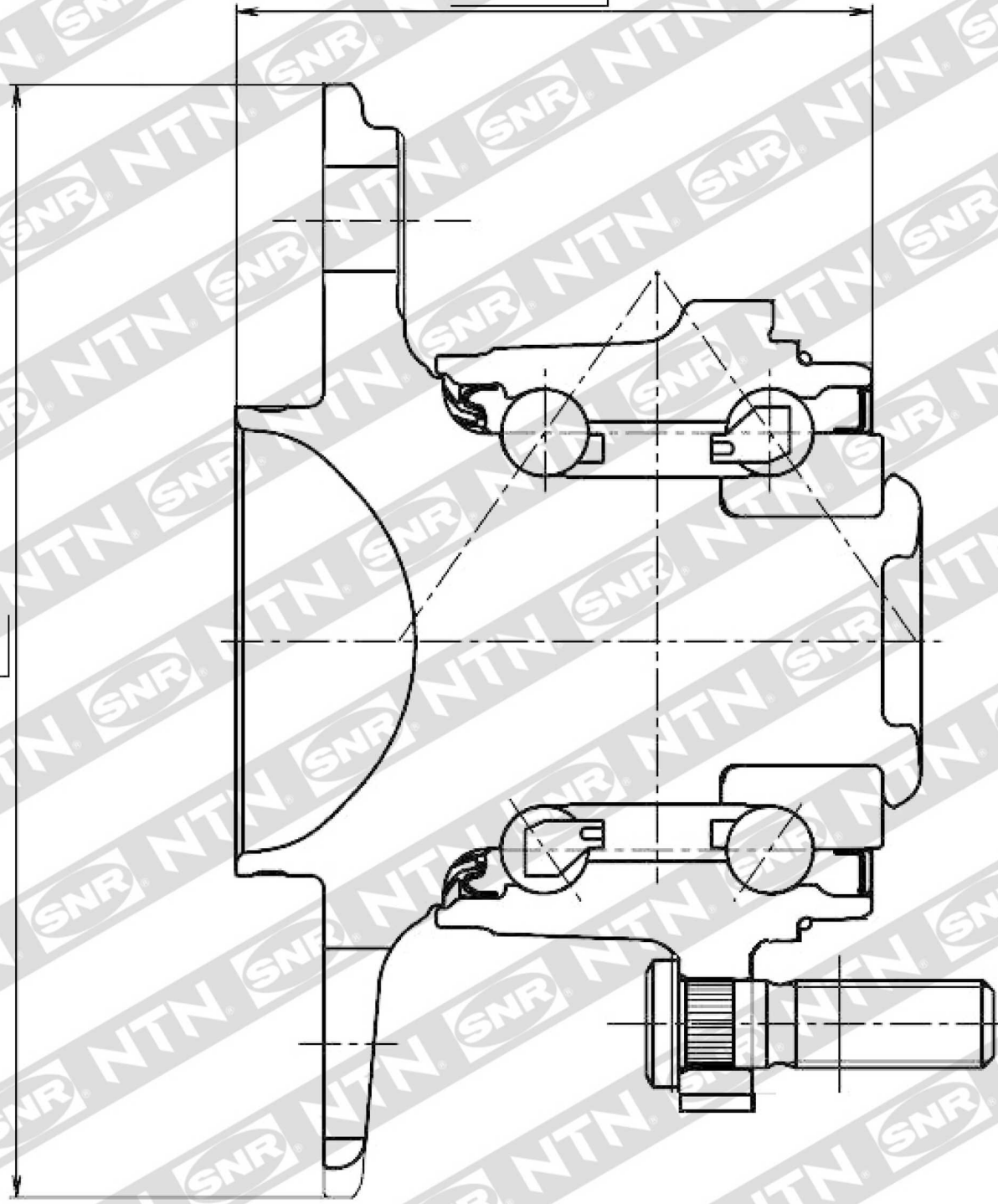

R15359