

87

120

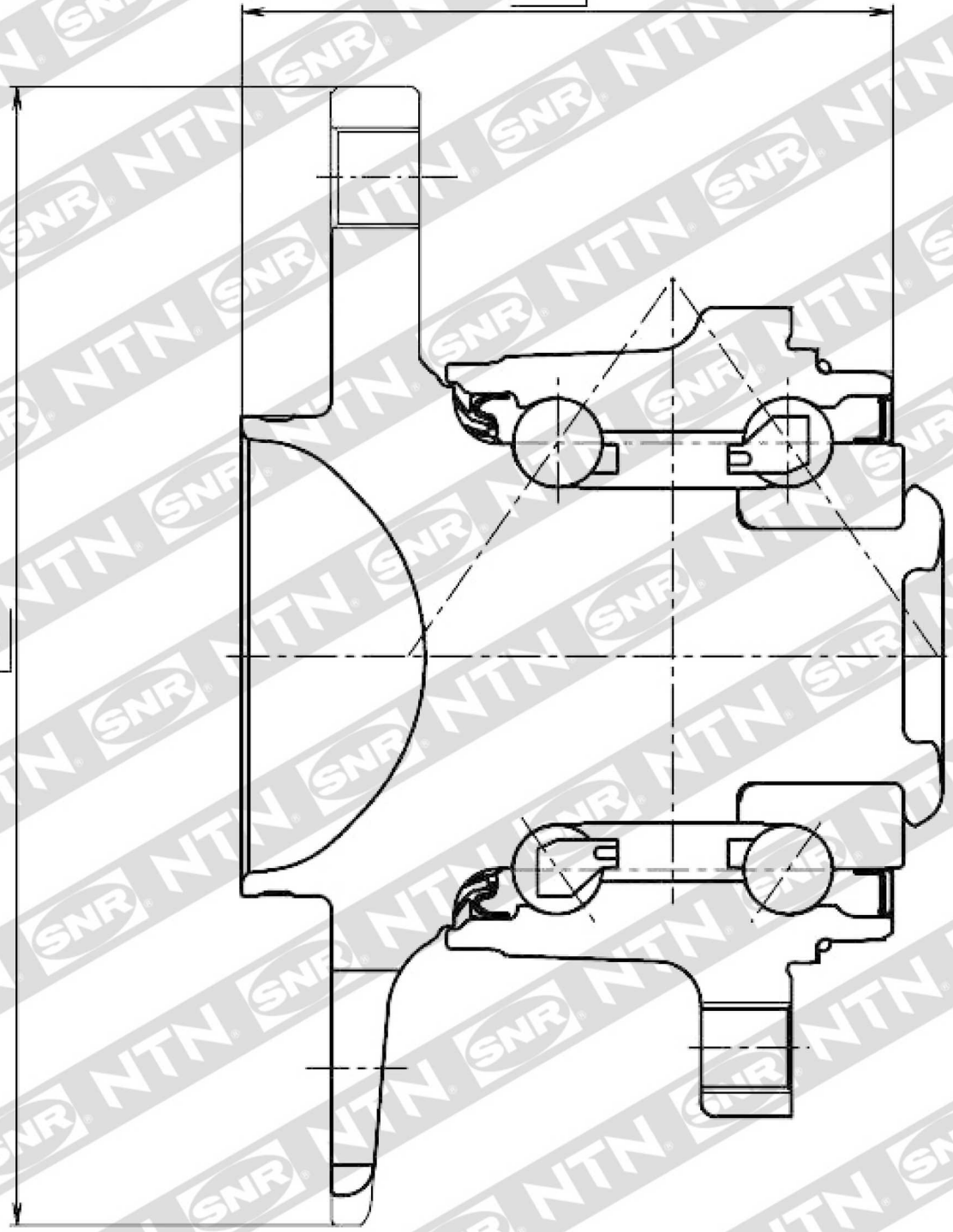

R15332