

85.3

136

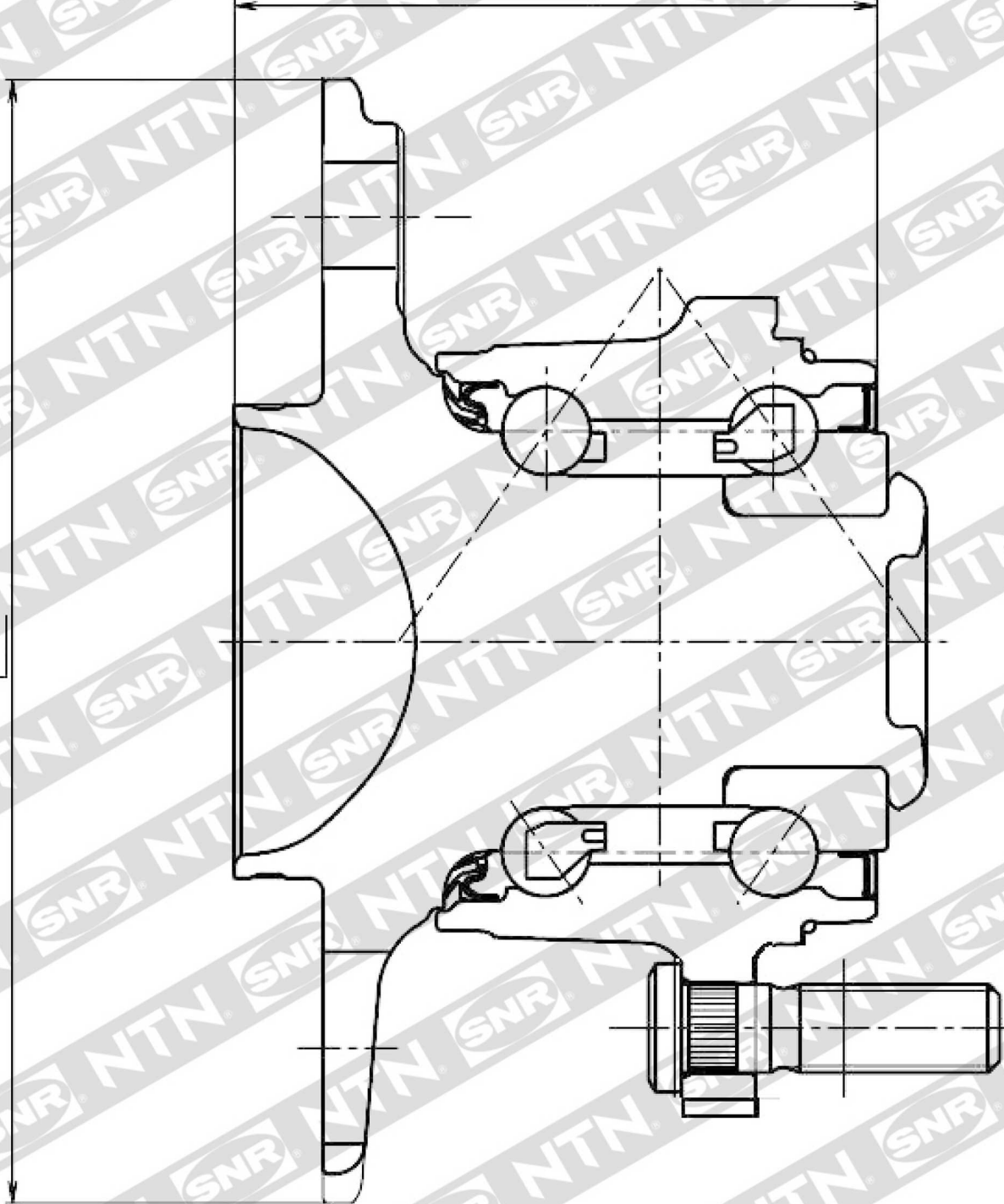

R15323