

88

145

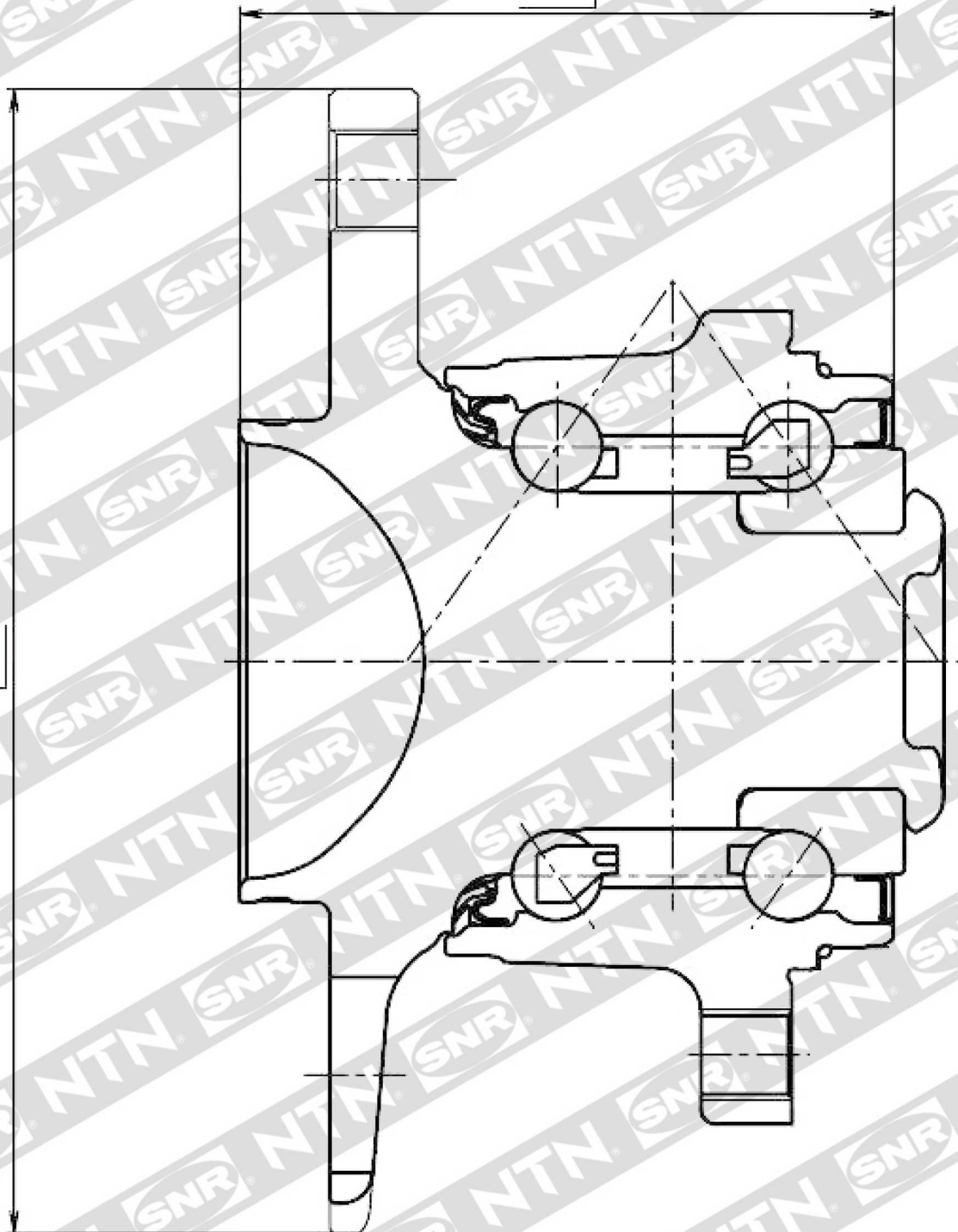

R15034